

### Highlights

- Ready-to-connect flexible LED-tape for professional color mixing
- Optimized Individual color calibration to generate white light from RGB LEDs
- Multichip LEDs placed under the same lens to achieve high quality color mixing – no rainbow effects
- Reflective white copper PCB for optimal system efficiency
- High quality adhesive 3M-tape on backside for easy mounting on common surfaces
- Available in two different lumen packages – High Efficiency (HE) and High Output (HO)
- Long lifetime: L70 = 50.000h Ⓞ

### Applications

- Wall Washing effects
- Accent Lighting
- Ambient Lighting
- Edge and Injection Lighting of transparent or diffuse materials

### Electrical Properties

- Supplied with constant voltage 24 VDC
- Connect up to 10 meters in series
- Optimized for high resolution dimming 0,1-100% using Tridonic and feno digital drivers controlled via DSI, DALI or DMX.

### Standards

→ page 2

### Mounting Instructions

→ page 4

### Accessories/Options

- Aluminum profiles for linear and corner applications
- Wide variety of lenses and covers 15°/30°/60°/120°/Asymmetric/Side-emitting
- Fixed or adjustable mounting brackets
- Solder-free connectors and bridges
- Large selection of drivers and dimmers to fit every need and application

→ page 7

Type	Article Code	Supply Voltage (VDC) ③	Power (W/m) ②	Typ. Data per meter ① ②				LED-quantity Pitch Distance (P) Cutting Length (C)	Dimensions LxWxH (mm)	Operating temp ta range (°C)
				Luminous flux (lm)   Current (mA)   Wavelength (nm)		Total				
				Red	Green	Blue	Total			
LEDtape RGB 500 HE	W1201-RGB	24	14,4	120 lm 211 mA 625 nm	240 lm 200 mA 550 nm	150 lm 189 mA 465 nm	510 lm 600 mA -	60 per meter 16,7 mm 100 mm	5000x10x2	-20 °C / +55 °C ④
LEDtape RGB 500 HE IP65	W1301-RGB	24	14,4	108 lm 211 mA 625 nm	216 lm 200 mA 550 nm	135 lm 189 mA 465 nm	459 lm 600 mA -	60 per meter 16,7 mm 100 mm	5000x14x6	-20 °C / +35 °C ④
LEDtape RGB 900 HO	W1202-RGB02450721	24	17,3	216 lm 253 mA 625 nm	432 lm 240 mA 550 nm	269 lm 227 mA 465 nm	917 lm 720 mA -	72 per meter 13,9 mm 83,6 mm	5000x10x2	-20 °C / +35 °C ⑤

① All values for ta = 25 °C

② Tolerance range for electrical and optical data ±15%

③ Exceeding the maximum operating voltage leads to an overload on the tape. This may result in a significant reduction in lifetime or even destruction of the tape. Tolerance range for the supply voltage 24V: +2V / -0V

④ Self-cooling at ta ≤ 35 °C

⑤ Cooling is required. Please see separate table for heat sink requirements.

## Standards

- EN 55015:2006 + A1:2007 + A2:2009
- EN 61547:2009
- EN 62471:2008
- IEC/PAS 62717

## Thermal behavior

Storage Temperature	-30/+60 °C
Operating Temperature	-20/+35°C/+55 °C
Tc max	75 °C

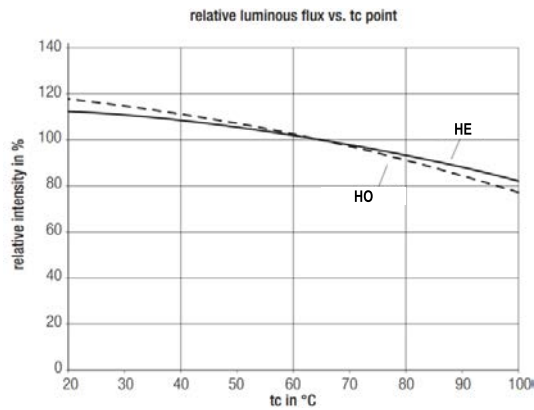

## ⚠ Thermal design and heat sink

The rated life of LED-products depends to a large extent on the temperature. Welight's excellent thermal design for the LED-tape products provides the lowest thermal resistance and therefore allowing new compact designs without sacrificing quality, safety and life time. However, if the permissible temperature limits are exceeded, the life of the LED-tape will be greatly reduced or the LED-tape may be destroyed.

It is often recommended to mount the LED-tape onto a heat sink, e.g. an aluminum profile. The need for a heat sink is largely depending on the ambient temperature (ta) of the application. The following tables should be seen as a guide to a recommended heat sink depending on different ta for the LEDtape RGB:

### LEDtape RGB HE (per meter)

Ambient Temperature (Ta)	Reference Temperature (Tc)	Cooling Area (cm²)	Thermal Resistance R <sub>HS-A</sub>	Recommended Aluminum profile
25 °C	65 °C	Self-cooling	Self-cooling	Optional
35 °C	65 °C	Self-cooling	Self-cooling	Optional
45 °C	65 °C	300	2,1 K/W	Z200-2 / Z201-2 / Z22W-2
55 °C	65 °C	400	1,8 K/W	Z22W-2

### LEDtape RGB HE IP65 (per meter)

Ambient Temperature (Ta)	Reference Temperature (Tc)	Cooling Area (cm²)	Thermal Resistance R <sub>HS-A</sub>	Recommended Aluminum profile
25 °C	65 °C	Self-cooling	Self-cooling	Optional
35 °C	65 °C	Self-cooling	Self-cooling	Optional
45 °C	Not allowed	-	-	-
55 °C	Not allowed	-	-	-

### LEDtape RGB HO (per meter)

Ambient Temperature (Ta)	Reference Temperature (Tc)	Cooling Area (cm²)	Thermal Resistance R <sub>HS-A</sub>	Recommended Aluminum profile
25 °C	65 °C	250	2,5 K/W	Z200-2 / Z201-2 / Z22W-2
35 °C	65 °C	350	1,9 K/W	Z22W-2
45 °C	Not allowed	-	-	-
55 °C	Not allowed	-	-	-

The temperature at tc reference point is crucial for the light output and life time of an LEDtape. For the welight LEDtape a tc temperature of 65 °C is recommended in order to achieve an optimum between heat sink requirements, light output and life time.

## Life time, lumen maintenance and failure fraction

The light output of the LEDs on the tape decreases over the life-time, this is characterized with the L value. L70 means that the LEDtape will give 70 % of its initial luminous flux. This value is always related to the number of operation hours and therefore defines the lifetime of the LEDs.

The L value is a statistical value and the lumen maintenance may vary over the delivered LEDtapes. The B value defines the amount of LEDs which are below the specific L value, e.g. L70B10 means 10 % of the LEDs are below 70 % of the initial luminous flux, respectively 90 % will be above 70 % of the initial value.

In addition the percentage of failed LEDs (fatal failure) is characterized by the C value. The F value is the combination of the B and C value. That means for F degradation and complete failures are considered, e.g. L70F10 means 10 % of the LEDs on the tape may fail or be below 70 % of the initial luminous flux.

Type	Ambient Temperature (Ta)	L90F10	L70F10
LEDtape RGB HE	25 °C	35 000 h	55 000 h
	50 °C	26 000 h	35 000 h
LEDtape RGB IP65	25 °C	24 000 h	50 000 h
	35 °C	16 000 h	30 000 h
LEDtape RGB HO	25 °C	24 000 h	50 000 h
	35 °C	16 000 h	30 000 h

**NOTE!** The temperature on the surface of the LEDtape (tc) may under no circumstances be higher than 65 °C if the expected lifetime of the LEDtape is to be met. Compliance with the maximum permissible reference temperature at the tc point must be checked under operating conditions in a thermally stable state. The maximum value must be determined under worst-case conditions for the relevant application.

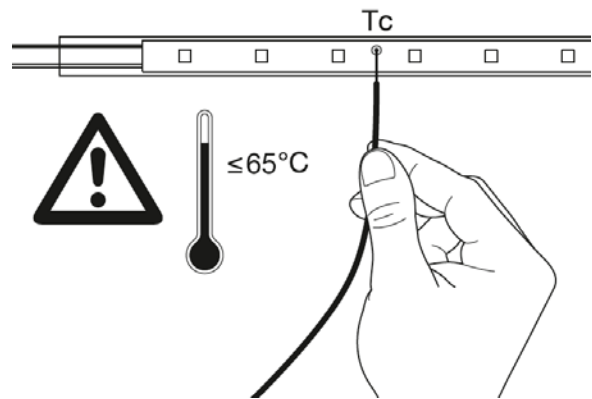

## Light Distribution

Radiance Angle = 120°

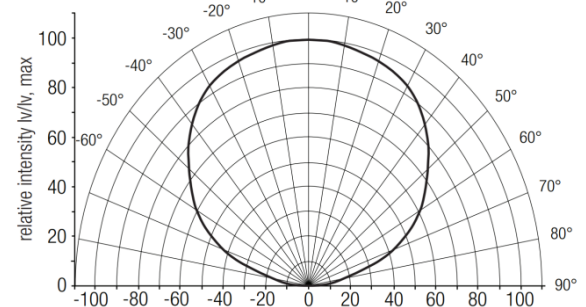

## CIE chromaticity diagram

Color	Dominant Wavelength (nm)
Red	625
Green	550
Blue	465

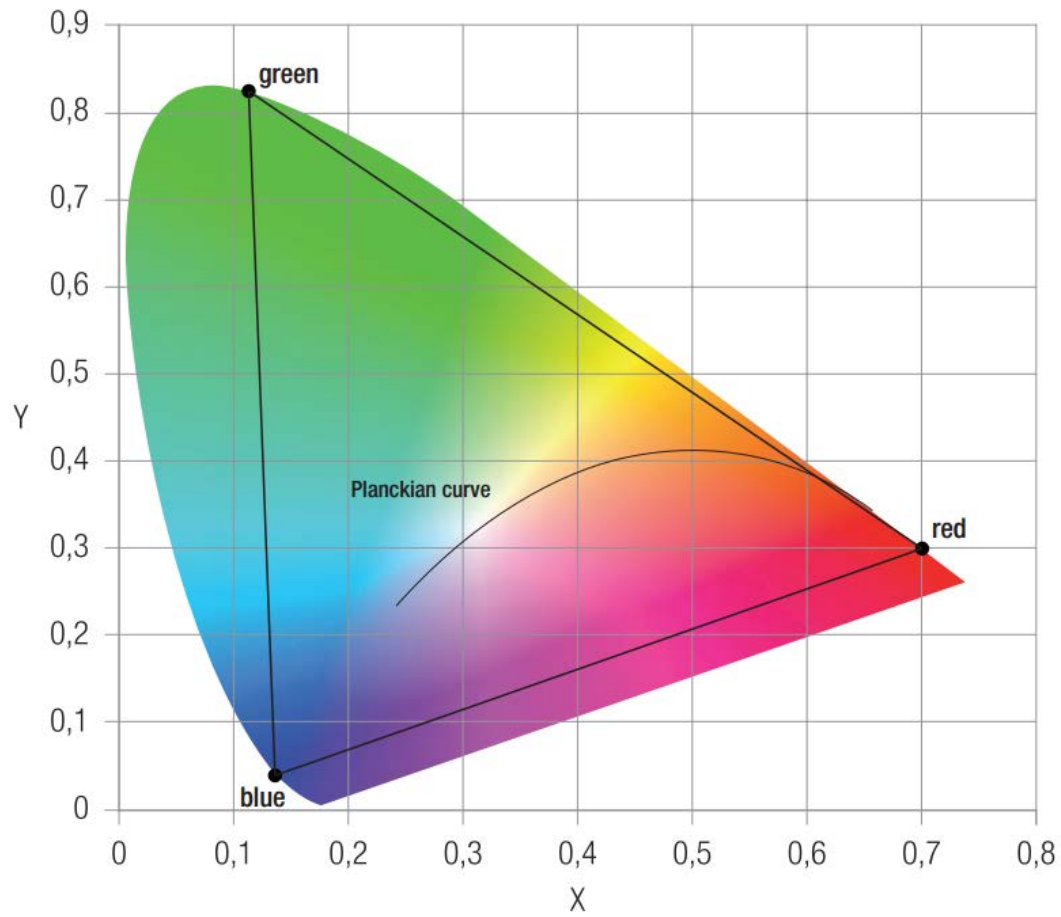

## Mounting Instructions

### Mechanical

The fixing/cooling surface must be properly cleaned to remove grease, dirt and silicon before application, e.g. using Isopropyl alcohol.

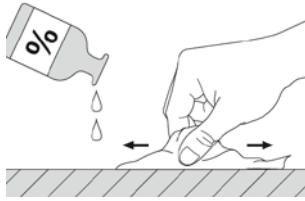

Never bend the LED-tape at a radius smaller than 50 mm. Assembly must not damage or destroy conducting paths on the circuit board.

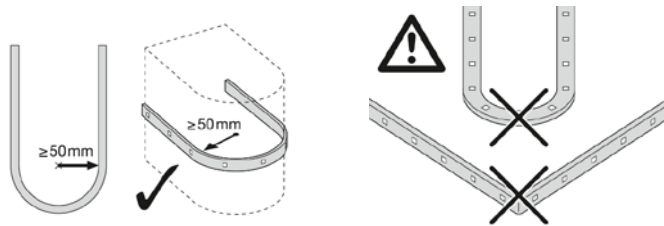

The LED module itself and all its components must not be mechanically stressed. When fixing the LED-tape to a surface, apply an even but gentle pressure and try to avoid applying pressure directly on the LED itself (the maximum allowed pressure is 20 N/cm<sup>2</sup>).

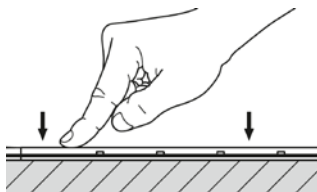

After assembly always check that the entire length of the tape has attached properly to the surface and that there is no air pockets underneath the PCB.

The thermal length expansion coefficient of the PCB is 17\*10<sup>-6</sup>cm/cm/K. When installing in environments with large variations in temperature (e.g. outdoor applications) and operating length of more than 2 m, the use of metallic mounting surfaces is necessary. Otherwise it is advisable to use an additional thicker adhesive tape to absorb the stress of any mismatch in expansion coefficients, e.g. 3M 9119-140 mic.

### Cutting

The LED-tape is separable at every 6 LEDs or multiple thereof with the full function of each LED segment. It is only allowed to cut the LED-tape at the indicated cutting line.

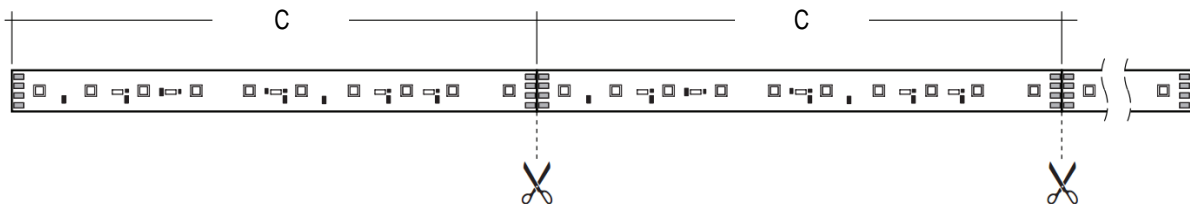

It is recommended to use the connection accessories listed below to split, connect, bridge and re-seal the LED-tape.

### Soldering

#### Without heat sink:

- Pre-tin the cables only
- Soldering temperature max 300 °C during 4 seconds

#### With heat sink:

- Pre-tin solder pads and cables
- Soldering temperature max 350 °C during 3 seconds

## Wiring Example

Each reel of LED-tape is delivered with color coded connection cable L=350mm, 4x0,5 mm<sup>2</sup>.

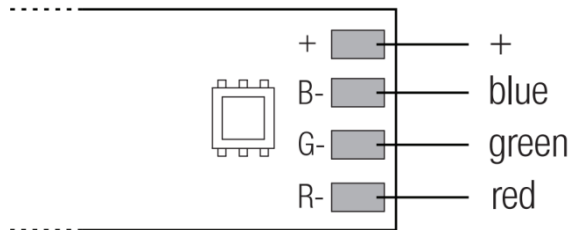

Do not connect more than 10 meters of the LED-tape in series. When connecting several sections in parallel as shown below please refer to the table *Driver & Control Systems* for the allowed total length connected to one controller/dimmer.

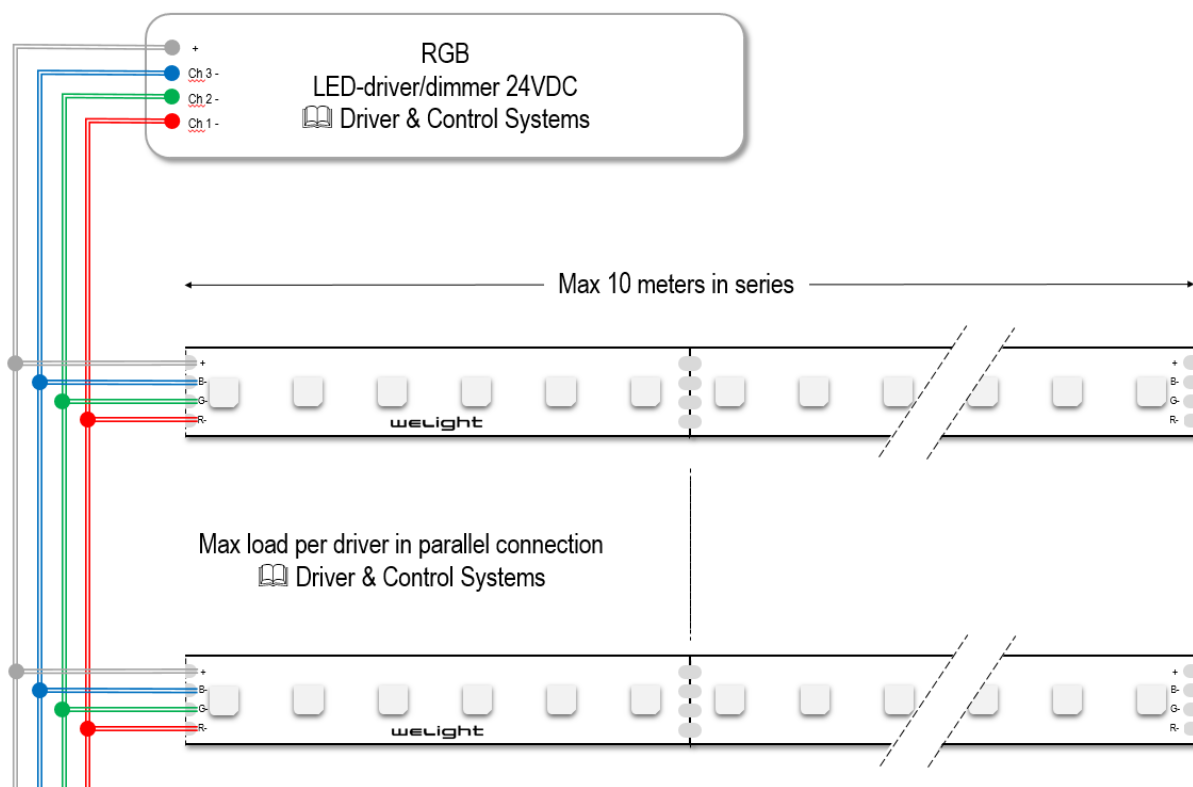

## LED Driver selection and connection

In order to drive weight LED-tapes safely, it is absolutely necessary to operate them with an electronically stabilized power supply protecting against short circuits, overload and overheating. Always use our approved drivers and controls to power the LEDtape – refer to *Driver & Control Systems*. If the wrong type of driver is used the product warranty is void.

Electronic control gear for LED should carry the CE mark and ENEC certified. In Europe the declarations of conformity must include the following standards: CE: EC 61347-2-13, EN 55015, IEC 61547 and IEC 61000-3-2 - ENEC: 61347-2-13 and IEC/EN 62384. Also check for the mark of an independent authorized certification institute. Tridonic electronic control gear complies with all relevant standards and guarantees safe operation.

## How to cut and re-seal the IP-rated LEDTape

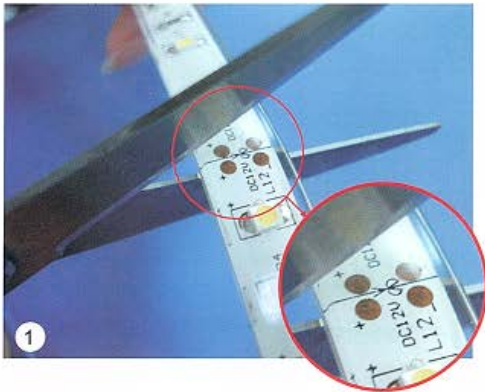

1. Please cut the LED strip at the cutting line.

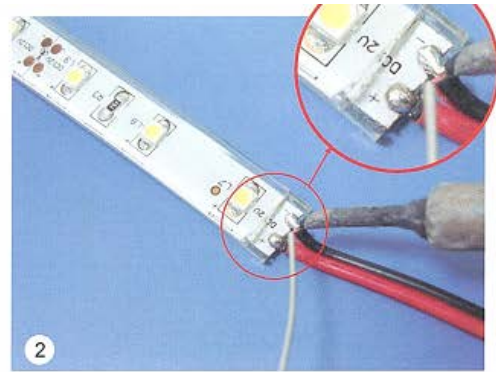

2. Rejoin the cables to the strip by soldering, please do not reverse the polarity.



3. Get the end-caps from the accessory bag, make a small hole on each end-cap.



4. Put the end-cap on the end of LED strip, get the wires through the small hole.



5. Twist off the cap of glue tube, make a hole on the tube with the awl of the cap or other sharp objects.



6-7. Put the needle on the top of glue tube, cut the top of the needle at an angle of 45-60 degrees.



8-9. Dispense the glue on the gap between the end-cap and LED strip, and the small hole on the end-cap. Please wait for 30 minutes till the glue gets solidified.

## Accessories

### Cable & Connection accessories

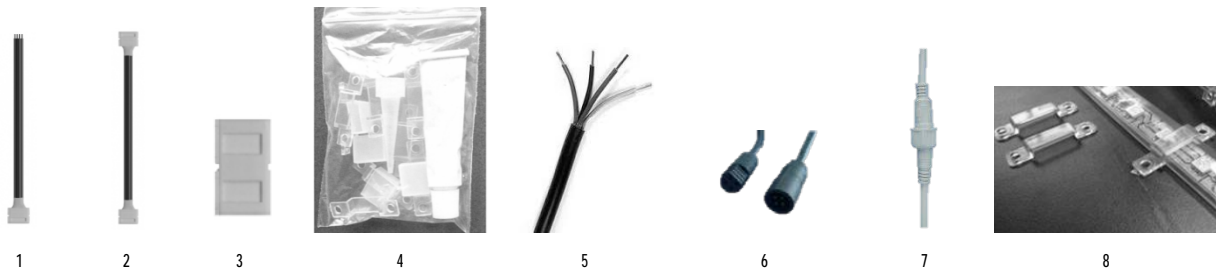

Type	Art. Code	Description	Suitable for LEDtape		
			HE	HE IP	HO
1	W8401	Supply cable with solder-free PCB-connection, L=200 mm	●	○	●
2	W8402	Bridge two LEDtapes with solder-free PCB-connection, L=200 mm	●	○	●
3	W8403	Bridge two LEDtapes directly to each other with solder-free PCB-connection	●	○	●
4	W8901	End Caps, Mounting Brackets & Silicon (one kit is included on delivery)	○	●	○
5	W8408	R2KB 4X0.35 Yd=4,8mm, Dark Grey, 100 m	●	●	●
6	W8412-A2	Quick Connector kit with female and male plug including 30 cm cable, black	●	○	●
7	W8411-A4	Quick Connector kit with female and male plug including 30 cm cable, white	○	●	○
8	W8902	Plastic mounting clips for all IP65-rated LEDtapes, 100 pcs per bag.	○	●	○

## Driver & Control Systems

(a) Select the way you want to control your system and (b) chose a driver that matches your LED-power.



(a)	Control Signal	Dimmer Type	Art. Code	LEDtape HE (max length)	LEDtape HO (max length)	Multiple dimmers allowed
1	Stand-alone color sequencer	Tridonic C002	86454968	10 meter	8 meter	No. Use booster type C004 to extend the installation.
2	1-10V	Tridonic C001	86454974	10 meter	8 meter	Yes
3	DALI	feno fd dali 3-24e	00001531	10 meter	8 meter	Yes
4	DALI integrated Ⓞ	Tridonic K211	86455066	1,5 meter	1,3 meter	Yes
5	DMX	feno fd dmx 3-24e	00000070	10 meter	8 meter	Yes
6	IP44 Dimmer Protection Kit	All of the above	24138842	-	-	-

Ⓞ The dimmer has a 25W integrated LED-driver and cannot be used together with external LED-driver in table (b).

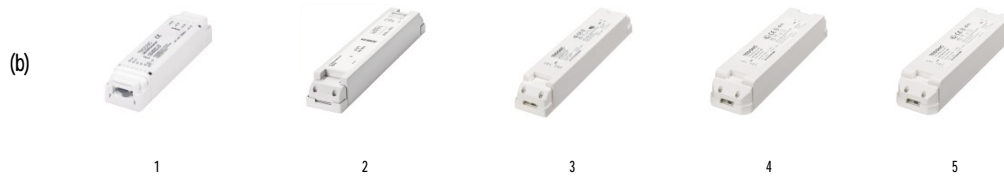

(b)	Driver	IP20 Art. Code	IP67 Art. Code
1	Tridonic LCU 025/24	86453418	-
2	Tridonic LCU 035/24	24166320	-
3	Tridonic LCU 060/24	24166324	22185184
4	Tridonic LCU 100/24	24166328	22185185
5	Tridonic LCU 0150/24	24166333	22185186

LED-drivers <25 W available on request. Please contact us at [info@ljuskontroll.com](mailto:info@ljuskontroll.com) for information about suitable end-user control interfaces, e.g. touch panels, color mixing software, potentiometers, push-buttons, etc.

## Aluminum Profile Systems

Start by selecting an aluminum profile (a) and a suitable lens cover (b) and then add optional accessories (c).

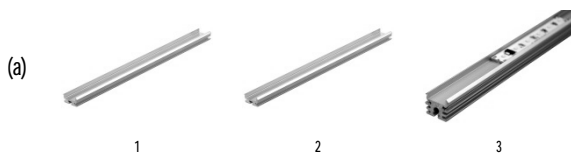

(a)	Type	Art. Code	L (mm)	W (mm)	H (mm)	W (mm) incl. lens cover	H (mm) incl. lens cover	Application	Optional accessories			
									Lens Cover	End Cap	Fixed Mount	Adjustable Mount
1	Z200-2	24166148	2000	18	9	21	16	Corner	●	○	○	○
2	Z201-2	24166149	2000	18	9	21	16	Linear Slim	●	●	●	○
3	Z22W-2	24166150	2000	18	16	21	24	Linear	●	●	●	●

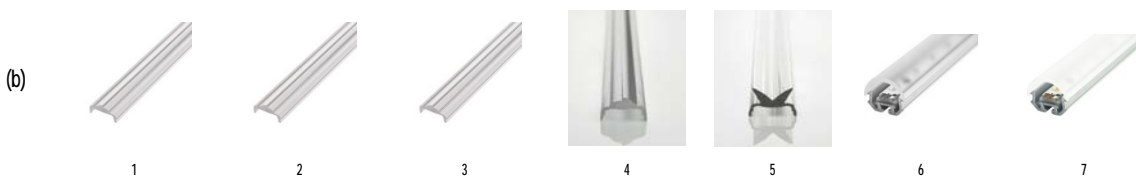

(b)	Type	Art. Code	L (mm)	Typ. application	Profile		
					Z200-2	Z201-2	Z22W-2
1	15°	24166409	2000	Wall wash	●	●	●
2	30°	24166410	2000	Wall wash	●	●	●
3	60°	24166411	2000	Shelf	●	●	●
4	30° x 60°	24166412	2020	Asymmetric	●	●	●
5	Batwing	24166120	2000	Side-emitting	●	●	●
6	120°	24138737	2000	Accent	●	●	●
7	120° opal	24138736	2000	Lines	●	●	●



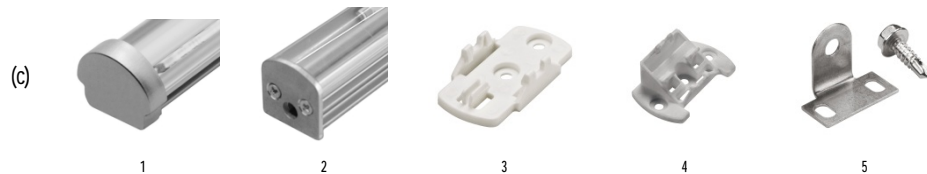

(c)	Type	Art. Code	Profile		
			Z200-2	Z201-2	Z22W-2
1	End cap Grey PMMA	24166334	○	●	○
2	End Cap Aluminum	24139174	○	○	●
2	End Cap Aluminum Cable Entry	24139173	○	○	●
3	Mounting Bracket 0°	88166859	○	●	●
4	Mounting Bracket 15°	88167372	○	●	●
4	Mounting Bracket 30°	88167373	○	●	●
4	Mounting Bracket 45°	88167374	○	●	●
4	Mounting Bracket 60°	88167375	○	●	●
5	Mounting Bracket Adjustable	24166024	○	○	●